



# BundleTutor

Transporter for heat exchanger tube bundles

Maintenance

Tube bundles handling



## A winning story since 1961

### The Beginning

At the end of the 1950s, Domenico Franco Agostino became the Italian representative of Albert Otto, a German manufacturer of tube expanders. In 1961 Franco Agostino's Albert Otto Italiana was founded and in 1972, after purchasing an area of 10,000 square metres in the municipality of Bagnolo Cremasco, Maus Italia Sas was established.

### The Growth

In 1976 his son Stefano, a mechanical engineer, joined the company. Together with his father, he studied products, introduced new machinery onto the market and filed the first patents by Maus Italia. Above all, Stefano was firmly convinced that people are the very heart of a company's success. Therefore, he invested in human capital by valuing people and roles, and he surrounded himself with skilled operators as well as technical, commercial and administrative collaborators. The result was a winning, competent and proactive team.

His daughter Anna - also a mechanical engineer - has been working in the company since 2016, giving new impetus and energy to the business her father and grandfather had built.

Father and daughter work together side by side every day to guarantee the excellence of Maus Italia and support all customers worldwide with competence and passion: the company's distinctive traits.



**Stefano Agostino**  
CEO - Mechanical Engineer

**Anna Agostino**  
COO - Mechanical and Management Engineer



## ***In-house production of each component*** ***Workshop 4.0 and 24/7 production control***

The production of Maus Italia branded items is entirely carried out in Bagnolo Cremasco, in the heart of an Italian industrial area 30 km southeast of Milan.

The company boasts a 4.0 workshop equipped with state-of-the-art machinery, an in-house heat treatment room and a final inspection department that allow Maus Italia to independently manage every phase of the manufacturing process of its wide range of products whilst maintaining high quality standards.



## ***Quality first.*** ***Design and development***

One of Maus Italia's strengths is its willingness to understand its customers' needs.

Our technical department is always ready to find operational solutions to the most complex applications, even via feasibility studies. We develop accurate work processes, draw with FEM analyses to verify our mechanical-structural performance and optimise the manufacturing process of each component.

## ***Ready To Deliver***

A well-stocked and complete warehouse of finished products enables Maus Italia ship quickly to customers all over the world according to a ready-to-deliver logic.

The warehouse is fully located within our premises in Bagnolo Cremasco at controlled temperatures and conditions to guarantee the maximum safety and quality of Maus Italia products for all our customers.

## ***Quality, environment and safety policy***

Research, quality and safety are the watchwords of Maus Italia Spa.

Maus Italia has several projects underway aimed at increasingly sustainable development and integrates environmental concerns into its business model. The company's actions, behaviour and development choices are focused not only on the short run but rather mainly on a medium and long-term horizon.



## ***Every day in over 80 country worldwide***

Find an official distributor in your country



# Tube bundles handling

*These machines, designed and manufactured by Maus Italia, are the result of decades of experience with hundreds of clients across five continents.*



## **BundleTutor Lifter**

For easy, safe and secure aerial handling of the tube bundle

Pag. 6

---



## **BundleTutor Mobil**

For the quick, safe and secure independent handling of the tube bundle

Pag. 22

---



# BundleTutor Lifter

*For easy, safe and secure aerial handling of the tube bundle*

Maus Italia presents the BundleTutor lifter for the aerial handling of tube bundles, for use both within the plant and during the production of heat exchangers. By lifting the tube bundle easily and safely, the BundleTutor lifter eliminates the risk of destroying the baffles and damaging the tubes.

The Maus Italia team is available to design custom solutions for extreme circumstances and ATEX / NAVY versions for the offshore market.

For independent handling using the BundleTutor mobil please refer to page 22.

**For production & onshore/offshore maintenance**



## **| Main features**

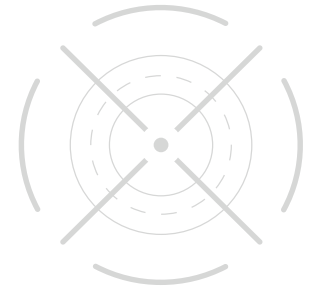

### ***Protects the tube bundle***

The BundleTutor lifter sustain and supports the tube bundle during handling using two complementary and independent feature (clamps and lifting slings), ensuring perfect support along its longitudinal axis and eliminating tensions and deformations.



### ***Easy to use***

The BundleTutor lifter is an extremely easy machine to use. A small number of intuitive controls allow the easy handling of the heavy tonnage of a tube bundle.



### ***Encircling***

The symmetrical clamps of the BundleTutor lifter and independent hydraulically controlled by the operator, can be easily adapted to the dimensions of the tube bundle to be lifted by encircling it carefully along its entire length.



### ***Wireless - Freedom of movement***

All movement and adjustment controls can be managed by remote control on request.

## **Optionals +**



### ***ATEX Certification***

The BundleTutor lifter can be manufactured on request according to the ATEX directive in an explosion proof configuration for use in environments with a potentially explosive atmosphere.



### ***DNV certification for FPSO and o shore platforms***

Maus Italia can manufacture, on request, the offshore BundleTutor Lifter NAVY version for the aerial handling of tube bundles on FPSO and platforms DNV ST-0378 , ST-E273 - MARITIME approved.



### ***Not afraid of the cold***

The BundleTutor lifter can be supplied, on request, in the special version suitable for operating at the very lowest of temperatures.



### ***Adapts according to need***

Maus Italia can design, on request and after technical verification, the BundleTutor lifter for bundle measurements and weights that differ from the standard product.

# BundleTutor lifter

Aerial tube bundle transporter

ASH welded hooks for hooks or slings

Independent symmetrical clamps covered with antistatic material for supporting the bundle



## Encircling

The independent symmetrical clamps, hydraulically controlled by the operator, can be easily adapted to the dimensions of the tube bundle to be lifted by encircling it along its entire length.

## X1 X2

Symmetrical opening and closing of the clamps with respect to the axis of the tube bundle to guarantee secure support and perfect centring:

Transverse opening  
**X + 600 mm (23.6")** per side.



## Coupling

In the BundleTutor lifter, the fixed coupling points are a simple and effective solution for fastening the tube bundle supporting slings. The use of a manual ratchet on the harness allows the easy securing of the tube bundle already supported by the clamps.





# BundleTutor lifter **super version**

Aerial tube bundle transporter with adjustable length

Frame with independent front and rear telescopic extensions

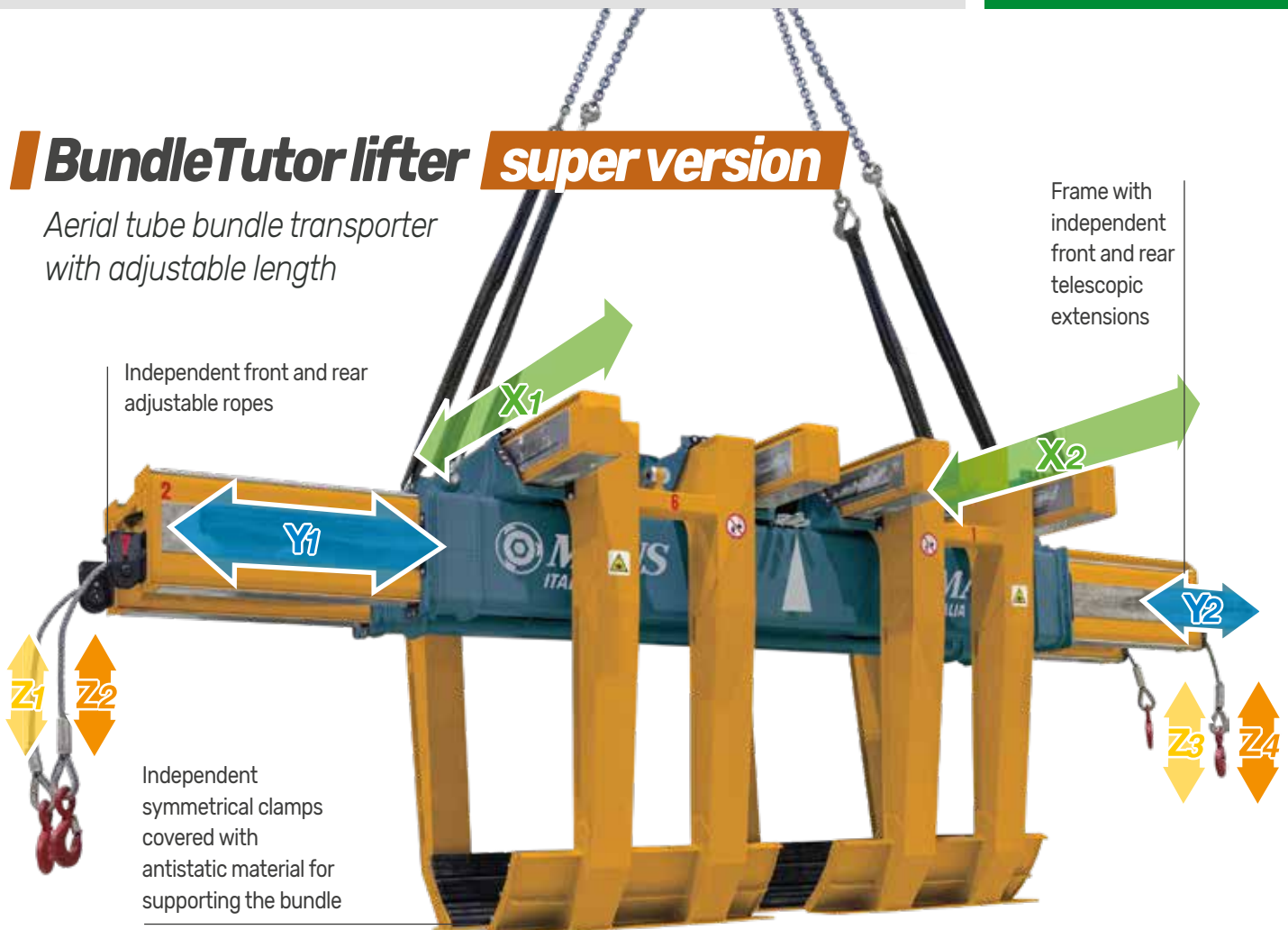

Independent front and rear adjustable ropes

Independent symmetrical clamps covered with antistatic material for supporting the bundle



## Encircling

The independent symmetrical clamps, hydraulically controlled by the operator, can be easily adapted to the dimensions of the tube bundle to be lifted by encircling it along its entire length.

## X1 X2

Symmetrical opening and closing of the clamps with respect to the axis of the tube bundle to guarantee secure support and perfect centring:

Transverse opening  
**X +600 mm (23.6")** per side.

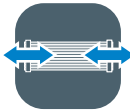

## Telescopic

Hydraulically controlled by the operator, the telescopic extensions extend the length of the most bulky of tube bundles, always ensuring perfect balance and support of the tube sheets.

## Y1 Y2

Independent telescopic extensions of the longitudinal slings for protection of long tube bundles where the weight of the overhanging parts would deform the tubes:

Longitudinal extension  
**Y +1000 mm (39.4")** front and rear.



## Compensates for errors

The control on the independent ropes, as well as improving the aligned support of the tube bundle, allows compensation (through rotation) for any potential positioning during setting down on the extractor.

## Z1 Z2 Z3 Z4

Independent strokes of the support ropes of the slings placed under the tube bundle facilitate precise alignment during subsequent insertion in the shell:

Vertical stroke  
**Z +700 mm (39.4")** front and rear.

# **BundleTutor lifter *super version***

*Combined use with Mef express HT tube bundle extractor*

## **1** Alignment with extractor and approaching

The BundleTutor lifter Super is aligned (using a crane or bridge crane) and surmounts the Mef express HT which carries the tube bundle to be moved.



## **2** Tube bundle sling and balancing

After having adapted to the dimensions of the tube bundle, the BundleTutor lifter Super harnesses it and, extremely carefully, lifts it using the support slings controlled by independent ropes, balancing it upon the longitudinal axis; The clamps, working symmetrically, centre and encompass the bundle, ensuring its support.



## **3** Lifting and handling of the tube bundle

The tube bundle is thus easily lifted, moved and set down in complete safety for scheduled maintenance.



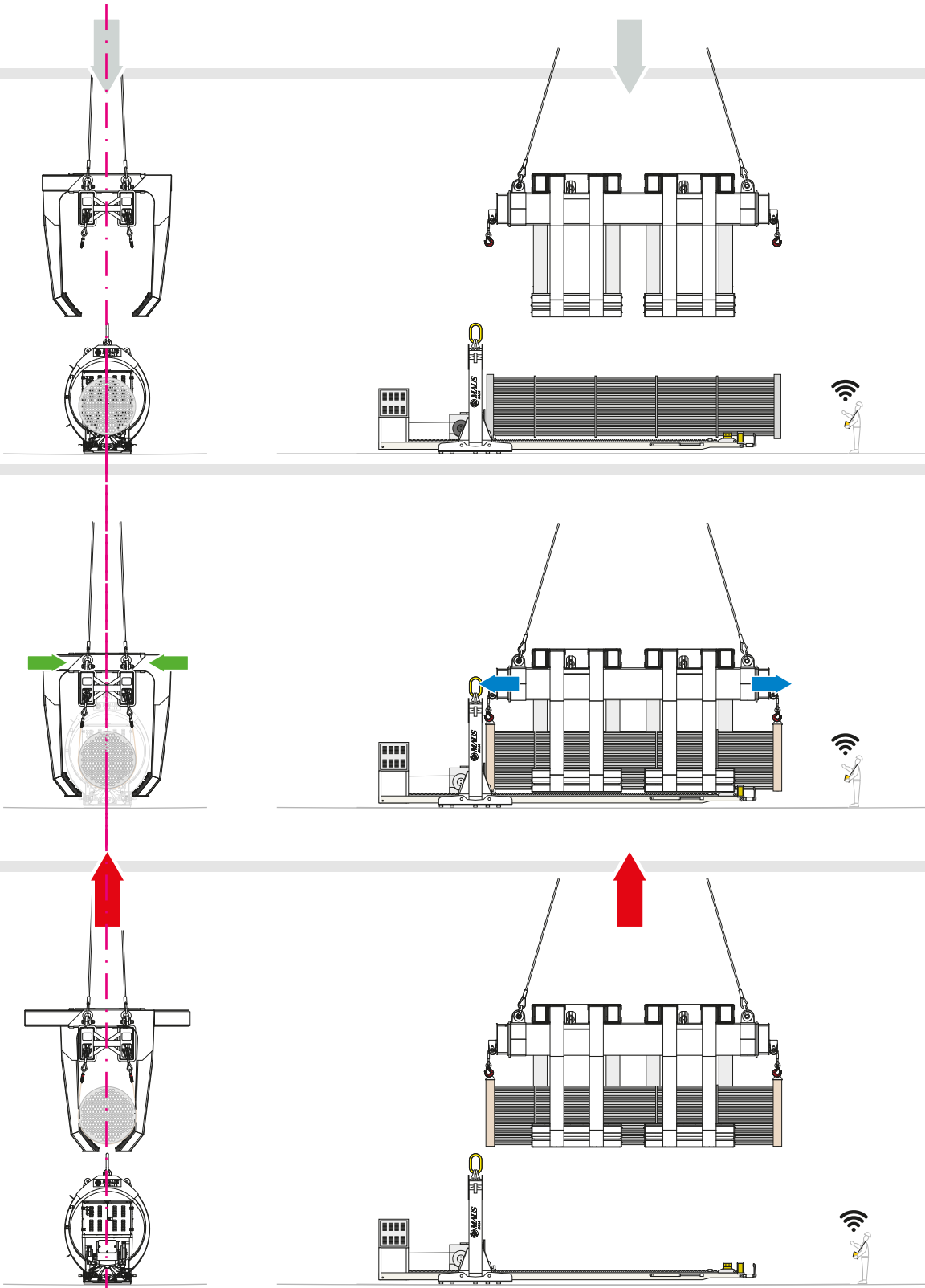

# Standard features

of our aerial tube bundle transporters



## Remote control with connection cable

Allows the operator to control all commands at a safe distance from the handling area without the often clutter connecting cable.  
( anyway supplied: 10m - 32.8ft )



## Wireless remote control

A practical remote control allows the operator to control all the commands, while remaining at a safe distance from the handling area.



## Catalytic flame arrestor with vibration damping

Fire and explosion protection device to limit combustion by extinguishing flames.



## Air-cooled diesel engine

The standard motorisation offered by Maus Italia consists of an air-cooled diesel engine.



## Structural analysis

During the 3D design phase, each BundleTutor lifter is subjected to structural analysis using the Finite Element Method. Predicting what will happen when the product is used allows for optimised and free design.

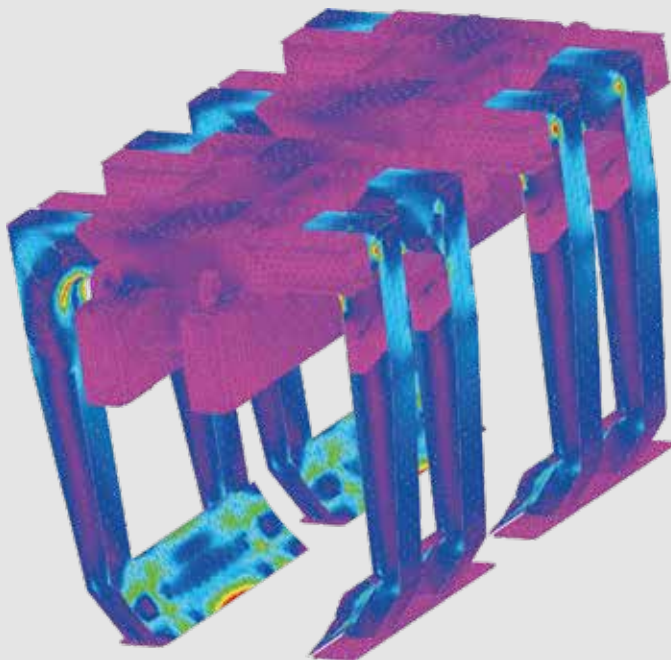

# Optional features

of our aerial tube bundle transporters



## Plug-in electric motor

For operation in closed spaces while respecting the environment and operator health, Maus Italia offer a fully electric version.



## Lifting slings

Maus Italia supplies double-layer polyester slings with a hooking system according to the BundleTutor lifter Super model and the size of the tube bundle to be handled.



## Ultrasonic sensor

The BundleTutor lifter can be equipped with 4 ultrasonic sensors to reliably detect, continuously and accurately, the distance to possible obstacles. A visual signal helps the operator at the crane or overhead crane during handling.

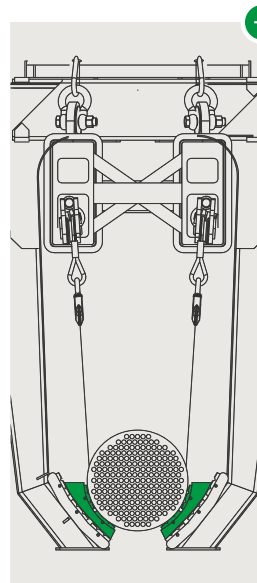
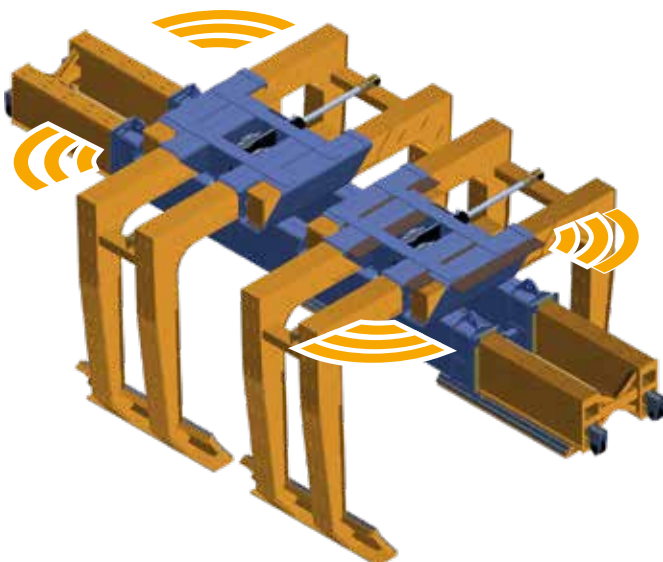

## Reducers for clamps

To improve grip on very small tube bundles, Maus Italia offers a reducer assembly coated with nitrile rubber (NBR 65) for the standard clamps. For particular size reductions, Maus Italia technical staff are available to suggest the most suitable solution and then design, build and supply the necessary components.

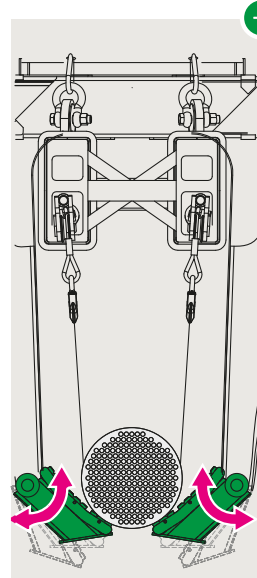

## Articulated clamps

Hydraulically assisted joints are the most efficient solution to guarantee an ergonomic grip. Additional hydraulic controls act on the joints of the clamps, adapting them to the shape of the tube bundle to be lifted.



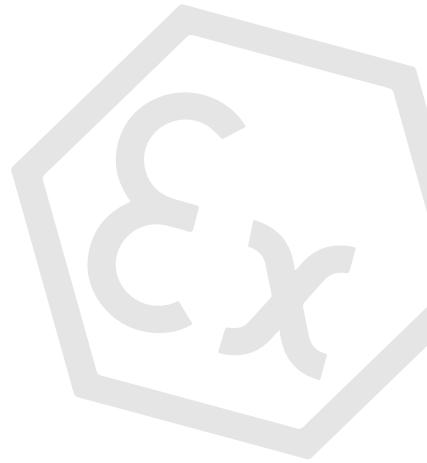

## **BundleTutor Lifter** **ATEX**

### **Certified construction of aerial tube bundle transporter**

Maus Italia, on customer request, can manufacture BundleTutor lifter in an explosion proof version, certified to operate in environments with potentially explosive atmospheres (ATEX) and on platforms/FPSO (DNV - MARITIME).

#### **Armoured engine components**

Components such as the alternator, the starter motor and the battery are insulated in explosion proof containers to prevent any sparks from entering the work environment.



#### **Armoured power circuits**

Power circuits are insulated in explosion proof containers to prevent any sparks entering the work environment.



#### **Combustion gas cooling**

Insertion of a heat exchanger and a vibration damper allows the rapid cooling of exhaust gases up to the values allowed by thermal class T.



For the North American market (Canada and USA), Maus Italia designs, manufactures and certifies tube bundle transporters according to the CSA reference standards.



### Overdrive control

A vacuum cutoff valve installed on the engine intake prevents the engine from overheating due to overdrive.



### Non-sparking stainless steel protections

Each sliding part is coated with stainless steel which also protects it from the accumulation of grease, thus avoiding any related maintenance.



The construction of an ATEX certified transporter is achieved by increasing its thermal and electric safety with components that have been designed to avoid in any way the ignition of gas which may be present in the working atmosphere.



The surface temperature of the each component and of the exhaust gases must remain below the threshold defined by the reference class T.



Any possible cause of a spark must be eliminated: from electrostatic charges to insulation in armoured containers of each power circuit.

Some of the solutions adopted for the construction of an ATEX handler are shown on this page.



# BundleTutor Lifter NAVY



**DNV**  
ST-0378 | ST-E273  
MARITIME



*For operation in the open sea where extreme conditions and erosion are merciless*

Maus Italia patents and certifies the BundleTutor lifter, with DNV GL approval, in a special NAVY version, which it offers for the aerial handling of tube bundles on offshore platforms and FPSO.

It concentrates anti-spark materials of the highest level suitable to withstand extreme situations and for operation in potentially explosive environments (ATEX) where every possible source of ignition must be eliminated. In addition to tests simulating offshore conditions, each component and the assembled machine have been subjected to the approval of the responsible certifier.

## Extremely offshore

Equipment certified for operation in hazardous areas ATEX Zone 2, IIA/B,T3

**BTL 22** | **BTL 22S**

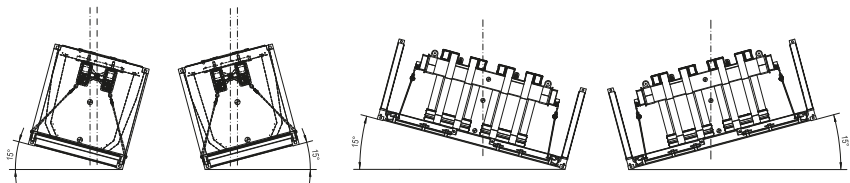

Maus Italia can manufacture, on customer request, offshore BundleTutor lifter handlers.

The DNV MARITIME certified transformation includes everything which has already been done to obtain ATEX certification with additional specifications for lifting accessories, movement and sizing guided by certification with more accurate process control.

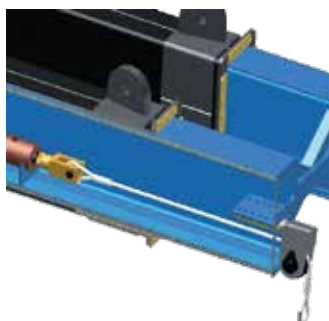

### Movement certification

Movement components, such as hydraulic cylinders and planetary gearboxes, are DNV certified for use in the open sea and in cases of extreme stress.



### Welding certification

Welds are subjected to magnetoscopic (or radiographic) examination to obtain DNV certification.



### Lifting certification

The supplied chains, shackles and lifting hooks are DNV certified for use on platforms and in cases of extreme stress.



# BundleTutor Lifter **E**



*For operation in closed spaces while respecting the environment and operator health*

Maus Italia offers a **fully electric version** of the BundleTutor lifter, especially for workshops and closed spaces where the use of a combustion engine causes an unhealthy environment.

The BundleTutor Lifter E is offered as a green solution with **zero emissions** and with autonomy of **over 25 working cycles**.



*7h of charging for 25 working cycles in full autonomy*



The reference diameter for gripping the tube bundles is that of the diaphragms, significantly lower than that of the relative tube sheet

## BundleTutor lifter

BundleTutor Lifter				BTL 30	
Lifting capacity (max.)	↑	T	lb	30	66000
Ø bundle baffes (min.)	d	mm	inches	600	23,6
Ø bundle baffes (max.)	D	mm	inches	1800	70,9
Length	A	mm	ft	4100	13,5
Width	B	mm	ft	3040	9,8
Width (closed)	BC	mm	ft	2060	6,8
Height	C	mm	ft	2300	7,6
Weight		T	lb	5,2	11470



BTL 22

## BundleTutor lifter *super version*

BundleTutor Lifter <i>super version</i>				BTL 30S	
Lifting capacity (max.)	↑	T	lb	30	66000
Ø bundle baffes (min.)	d	mm	inches	600	23,6
Ø bundle baffes (max.)	D	mm	inches	1800	70,9
Length	A	mm	ft	6580	21,6
Length(closed)	AC	mm	ft	4580	15,0
Width	B	mm	ft	3040	9,8
Width (closed)	BC	mm	ft	2060	6,8
Height	C	mm	ft	2300	7,6
Weight		T	lb	6,5	14330



### Customized

Maus Italia can design, on request and after technical verification, the BundleTutor lifter with diesel or electric motorisation for bundle measurements and weights that differ from the standard product.

# BundleTutor lifter

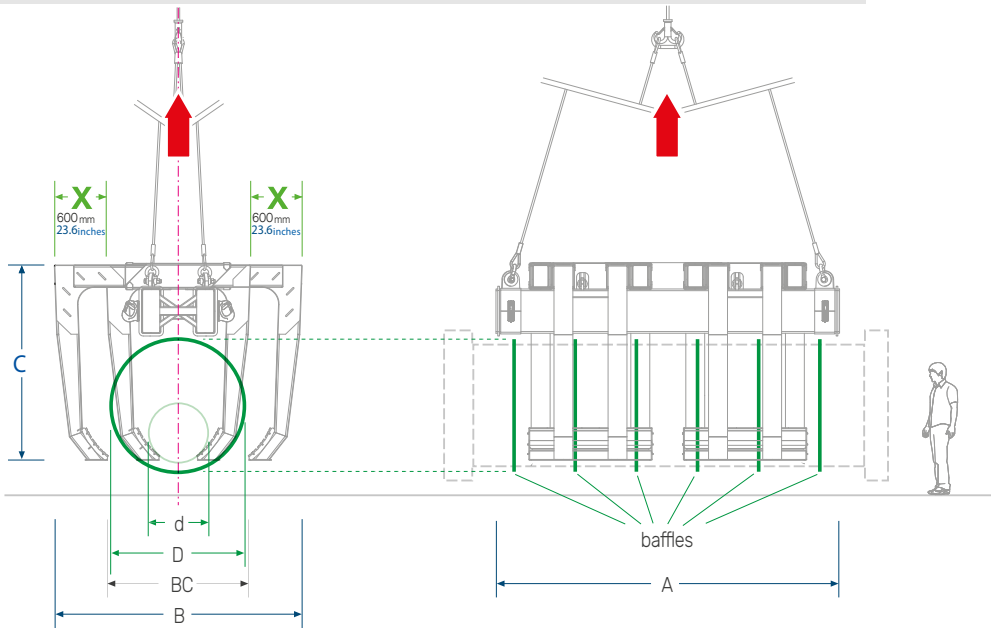

# BundleTutor lifter **super version**

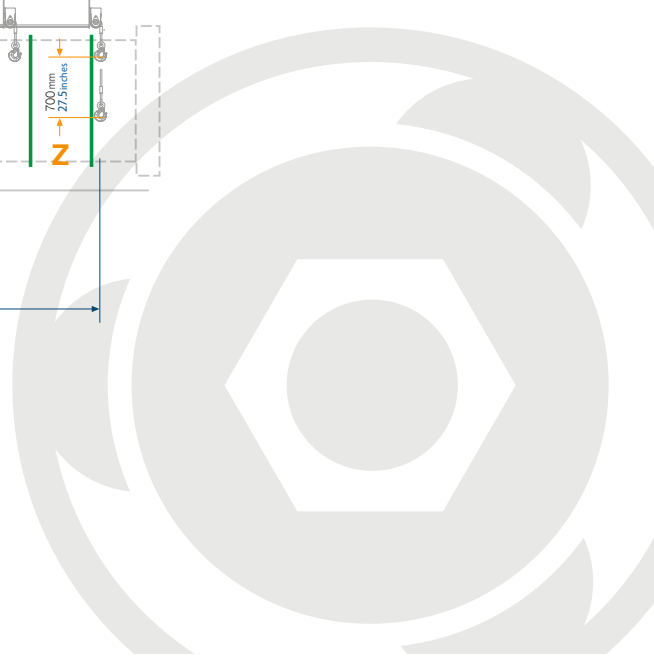
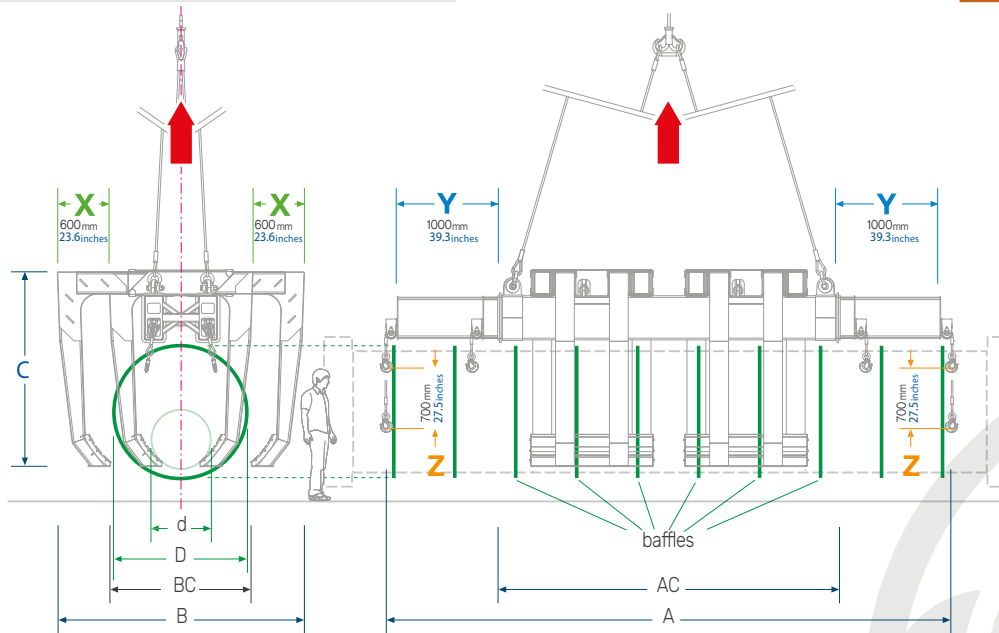

## Motorisation of aerial tube bundle transporters

Maus Italia offers the engines listed below for its diesel and electric versions. Different engines are available upon request to meet the requirements of the country where the BundleTutor lifter will operate or for particular required emissions certificates.

<b>Motorisation</b>			<b>BundleTutor Lifter D</b>	
Model	YANMAR L100V6 *			
Type	4 stroke - air cooled			
Suction	Natural			
Combustion system	Direct Injection			
Cylinders	1			
Displacement	l	<b>inches<sup>3</sup></b>	0,435	<b>26.5</b>
Nominal power (@ 3600 rpm)	kW	<b>HP</b>	6,8	<b>9.1</b>
Fuel Oil Tank Capacity	l	<b>US Gal</b>	5,4	<b>1,43</b>
Fuel consumption (full load - continuous use)	l/h	<b>US Gal/h</b>	0,9	<b>0.24</b>

\* or equivalent



<b>Motorisation</b>			<b>BundleTutor Lifter E</b>	
Engine performance with S2 (ED)	kW		4,0	
Electrolyte	Sulfur acid thixotropic gel			
Battery voltage/rated battery capacity	V/Ah	<b>V/Ah</b>	6/198	<b>6/198</b>
Number of batteries	8			
Battery weight	Kg	<b>lb</b>	31	<b>69</b>
Charging time from discharge	h	<b>h</b>	7	<b>7</b>
Optional charging station	Fixed position / On-board			





# BundleTutor Mobil

*For the quick, safe and secure independent handling of the tube bundle*

Maus Italia offers the BundleTutor mobil for the handling of tube bundles independently of cranes and trucks inside the plant, speeding up loading and unloading of Mef express HT bundle extractors and transportation from the extraction point to the washing area or maintenance workshop.

The Maus Italia team is available to design custom solutions to provide solutions for extreme cases and ATEX explosion proof and NAVY versions for the offshore market.

For aerial handling with BundleTutor lifter please refer to page 6.

## **For maintenance**



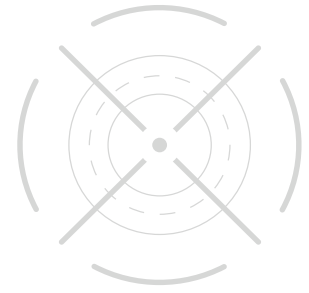

## **| Main features**



### **Total protection of the bundle**

The BundleTutor mobil sustain and supports the tube bundle during handling using two complementary and independent feature ( clamps and lifting slings ), ensuring perfect support along its longitudinal axis and eliminating tensions. and deformations.



### **Compensates for errors**

The BundleTutor mobil, thanks to its independent adjustable ropes, compensate (through the rotation of the tube bundle) for any potential positioning errors during setting down on the extractor. This facilitates its subsequent insertion into the shell of the heat exchanger.



### **Nimble**

The BundleTutor mobil is an evolved 4x4 with front/rear driving and steering wheels that allow extremely small turning circles and rapid positioning. Independent shock absorbers also allow it to compensate for unevenness in the road surface.



### **No crane/truck - Independent**

Neither trucks nor cranes are required for handling the tube bundle inside the plant for loading and unloading.



### **Wireless - Freedom of movement**

All movement and adjustment commands are managed by remote control.

## **Optionals <sup>+</sup>**



### **Adapts according to need**

Maus Italia can, on request and after technical verification, design the BundleTutor mobil for bundles with measurements and weights different from its standard product.



### **ATEX certification**

The BundleTutor mobil can be manufactured, on request, according to the ATEX directive in an explosion proof configuration for use in environment with a potentially explosive atmosphere.



### **Not afraid of the cold**

The BundleTutor mobil can, on request, be supplied in the special version suitable for operating at the very lowest of temperatures.



### Compensates for errors

The control on the independent ropes, as well as improving the aligned support of the tube bundle, also allows compensation ( through rotation ) for any potential positioning errors during setting down of the extractor.

### Z1 Z2 Z3 Z4

Independent strokes of the support ropes of the slings placed under the tube bundle facilitate precise alignment during subsequent insertion in the shell:

Vertical stroke

**Z+700 mm (39.4")** front and rear.





# BundleTutor lifter

Combined use with the Mef express HT tube bundle extractor

Each component is designed in 3D and tested in a virtual environment before being produced

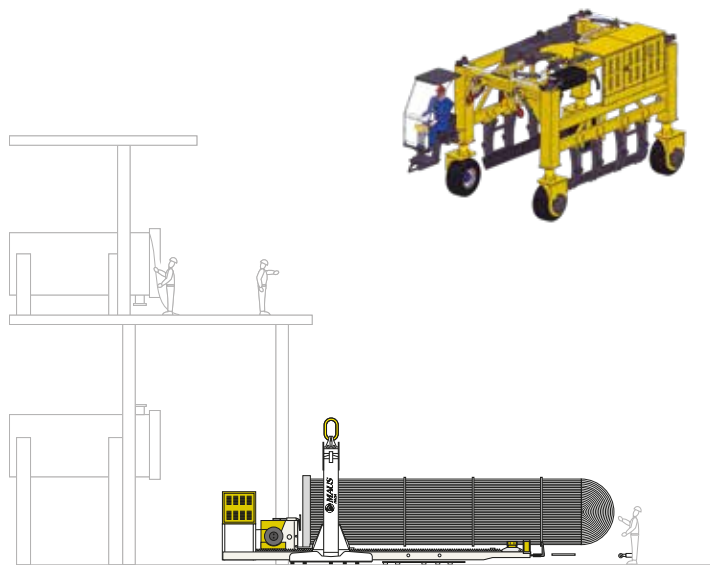

The BundleTutor mobil is used for the handling of tube bundles inside the plant in combination with a Maus Italia tube bundle extractor from the Mef express HT series.

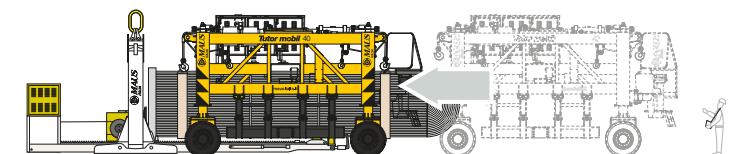

**Alignment with the extractor and approaching**

**1** The BundleTutor mobil aligns easily ( thanks to the 4 driving and steering wheels ) and surmounts the Mef express HT which carries the tube bundle which has just been extracted;

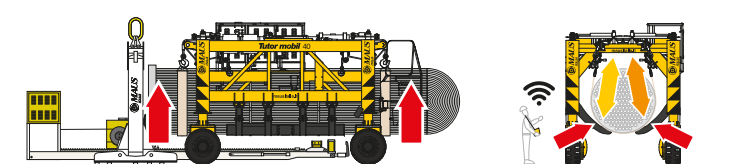

**Harnessing of the tube bundle and balancing**

**2** Using the support slings which are controlled by independent ropes, the BundleTutor mobil harnesses the tube bundle and lifts it with extreme care. Working symmetrically, the clamps centre and encircle the bundle, ensuring that it is balanced along its longitudinal axis;

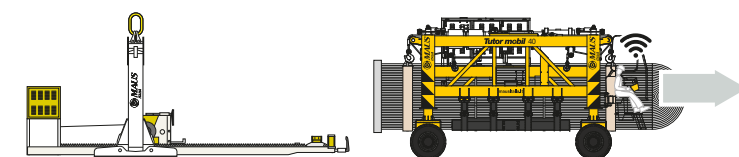

**Lifting and handling of the tube bundle**

**3** The tube bundle is transported and unloaded at its destination inside the plant in complete safety for scheduled maintenance without the use of trucks or cranes.

# **Standard features**

*of independent tube bundle transporters*



## **Air-cooled diesel engine**

The standard engine consists of an air-cooled diesel engine sized to fit the proposed BundleTutor mobil model.



## **Cushioning system**

Each of the BundleTutor mobil 's wheels has an independent cushioning system to ensure the stability of the load during moving on uneven surfaces.



## **Catalytic flame arrestor with vibration damping**

Fire and explosion protection device to limit combustion by extinguishing flames.



## **Removable driving seat with remote control housing**

Using the wireless remote control, the operator can choose whether to sit comfortably in the driver's seat or accompany the BundleTutor mobil at a distance.



## **Very short tube bundles**

Four deflection pulleys facilitate the loading of shorter tube bundles by moving longitudinally, within the BundleTutor mobil, the descent point of the independent harnessing cables.



## **To see better and to be noticed**

The BundleTutor mobil is equipped with 4 LED headlights for front and rear lighting and 2 warning lights.



## Optional features

of independent tube bundle transporters



### Liquid-cooled diesel engine

When air-cooling is insufficient or unsuitable for current regulations, Maus Italia can offer engines with low environmental impact and liquid cooling.



### Lifting slings

Maus Italia supplies double-layer polyester slings with a hooking system suitable for the BundleTutor mobil model and the size of the tube bundle to be handled. For special circumstances, the Maus Italia technical staff are available to customers to suggest the most suitable solution and to provide the necessary material.



### Articulated clamps

Joints are a very efficient solution for guaranteeing an ergonomic grip. The clamps, thanks to their articulated joints, adapt to the shape of the tube bundle to be handled.

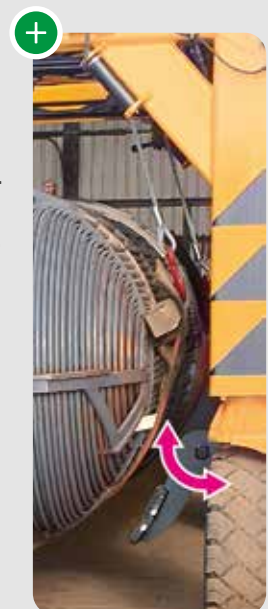

# Technical features

of independent tube bundle transporters



## Nimble Extremely small turning circles

Particular attention has been paid to the agility of the BundleTutor mobil which, with 4-wheel drive and steering, is able to navigate the journey within the plant.

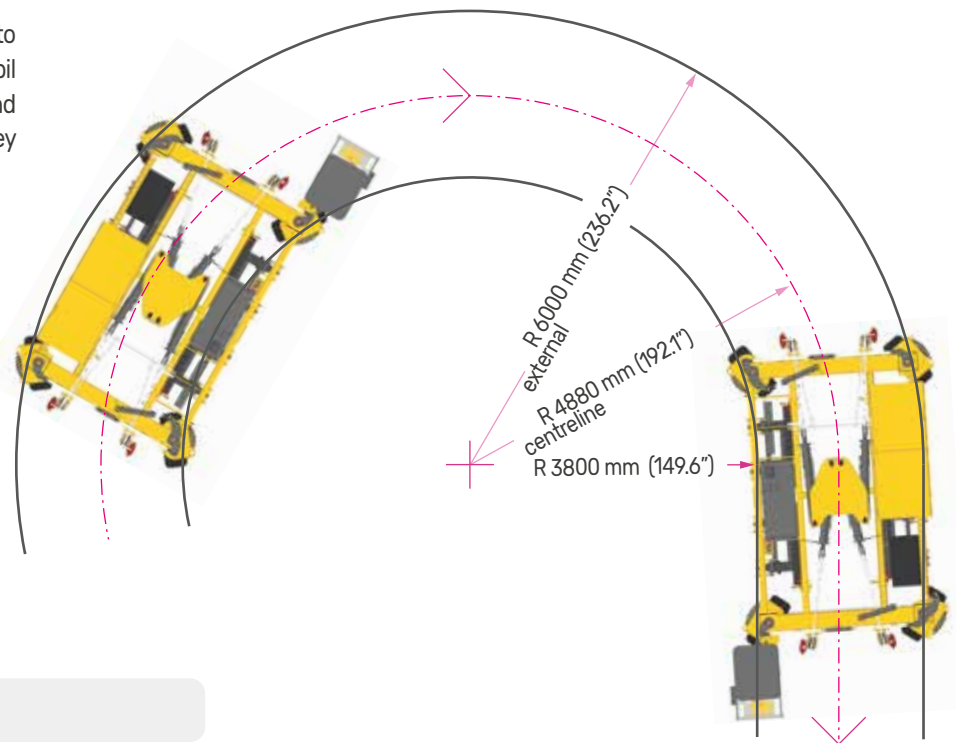
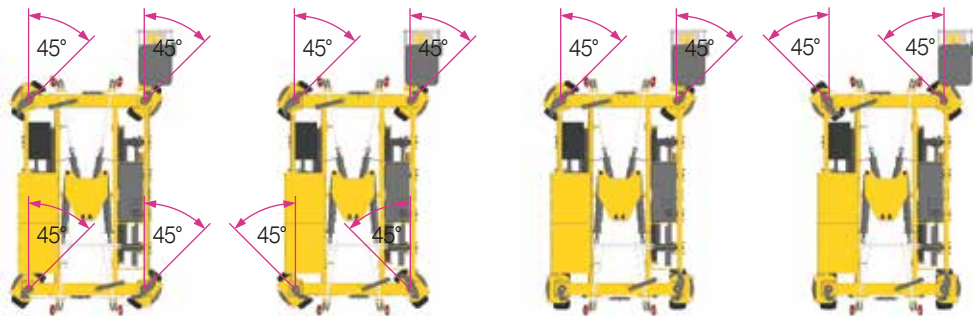

## Wireless

### Remote control commands

- Front driving and steering
- Speed regulation
- Front lift
- Rear lift
- Rear steering
- Horn
- Emergency
- Engine speed
- Opening and closing of the bundle support clamps
- Receiver connection activation
- Engine start and stop



# Technical features

of independent tube bundle transporters

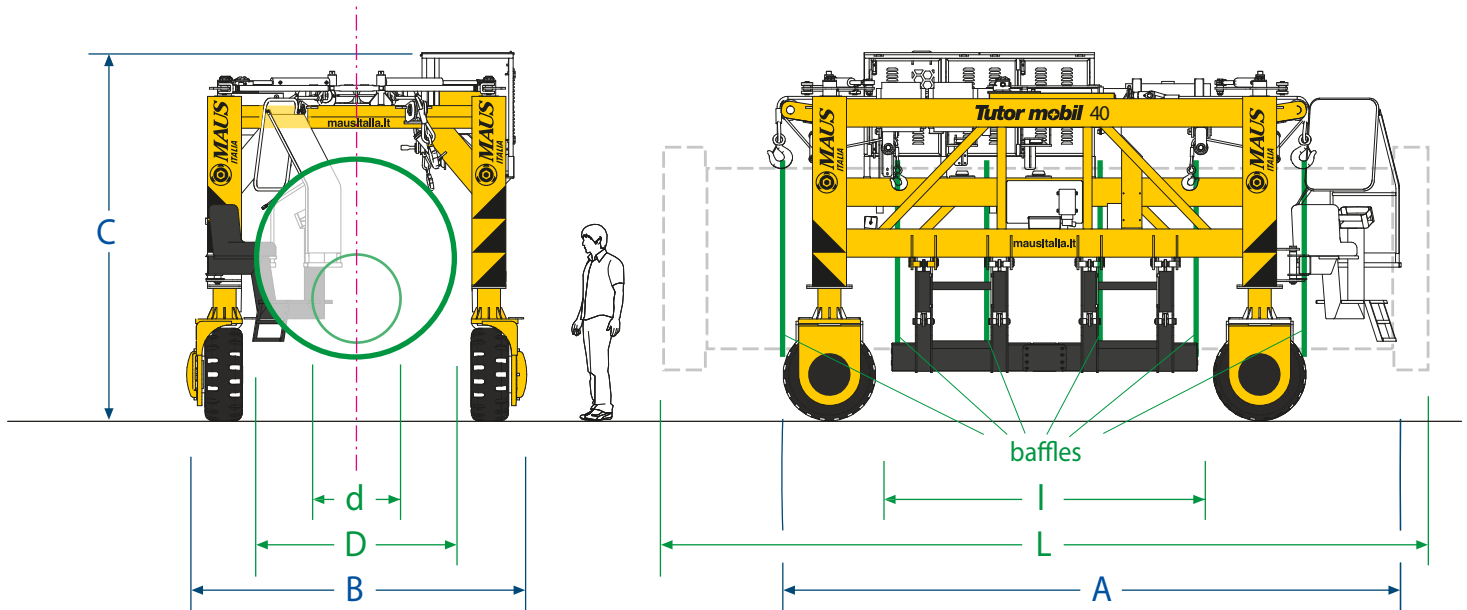

### Working capacity

Ø bundle baffles (min.)	d	mm	inches	400	15.7
Ø bundle baffles (max.)	D	mm	inches	2000	78.7
Bundle length (min.)	l	mm	inches	/	/
Bundle length (max.)	L	mm	inches	7500	295.3
Lifting capacity (max.)	T	lb		40	88000
Speed with no load (max.)		km/h	mph	7	4.3
Speed at full load (max.)	R	mk/h	mph	4	2.5
Minimum turning radius		mm	inches	3800	149.6
4 wheel steering (max.)				+/- 45°	+/- 45°
Negotiable slope (max.)				10%	10%

### BundleTutor Mobil

### Dimensions

### BundleTutor Mobil

Length	A	mm	ft	5490	18.0
Width	B	mm	ft	2720	8.9
Height	C	mm	ft	3260	10.7
Weight	T	lb		8,5	18700

### Motorisation

### BundleTutor Mobil

Model	JOHN DEERE - PowerTech™ PWL 4.5L Engine *			
Suction	Aftercooler air-air			
Combustion system	Direct Injection			
Cylinders	4			
Displacement	l	inches <sup>3</sup>	4,5	275
Nominal power	kW	HP	93	125
Noise @ 1m	dB(A)	dB(A)	92,5	92,5
Emissions certifications	CARB EPA Tier 4 EU Stage IV			

\* or equivalent

# Heat exchanger's world

---

**MAUS ITALIA SPA IS THE WORLD LEADING MANUFACTURER OF TOOLS AND MACHINES FOR THE PRODUCTION AND MAINTENANCE OF HEAT EXCHANGERS**



**Maus Italia S.p.A.**

SP 415 KM 30 ( nuova strada di arrocco )  
26010 Bagnolo Cremasco ( CR ) Italy  
PIVA: 00141010199

Telefono: +39 0373 2370

info@mausitalia.it  
www.mausitalia.it





**mausitalia.it**

